



# GAMME DÉCORATIVE



# JAZZ. NOUVEAUTÉ 2023

SÈCHE-SERVIENTTES HYDRAULIQUE / ÉLECTRIQUE / MIXTE



RADIATEUR CONTEMPORAIN EN ACIER AVEC TUBES RECTANGULAIRES 25 x 20 MM ET COLLECTEURS CARRÉS 30 x 30 MM

LA FINITION BISEAUTÉE SUR LES TUBES APPORTE UNE TOUCHE D'ORIGINALITÉ

VERSION ÉLECTRIQUE : THERMOSTAT SMART PLUS LED AVEC REGULATION DE LA TEMPÉRATURE, BOOST 2H, TIMER 12/24H (BOOST PROGRAMMABLE UNE OU DEUX FOIS PAR JOUR)



APPAREIL RÉVERSIBLE

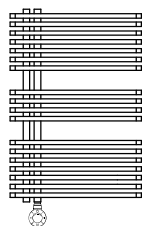
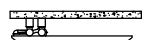

JAZZ 88

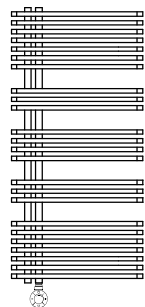

JAZZ 126

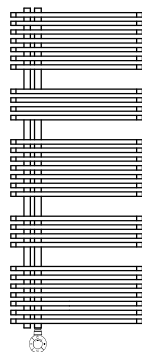

JAZZ 146

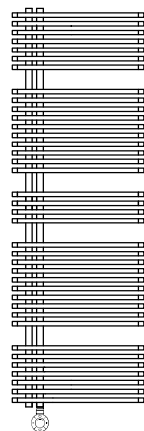

JAZZ 182

— ΔT 50 °C

88 x 50 CM  
BLANC 300 W 415 W

— ΔT 50 °C

126 x 50 CM  
BLANC 500 W 541 W

— ΔT 50 °C

146 x 60 CM  
BLANC 700 W 731 W

— ΔT 50 °C

182 X 60 CM  
BLANC 1000 W 909 W



50 RAL À CHOIX  
NUANCIER P.156

JAZZ. HYDRAULIQUE

# BLUES. NOUVEAUTÉ 2023

SÈCHE-SERVIETTES HYDRAULIQUE / ÉLECTRIQUE / MIXTE  

FINITION INOX HAUT DE GAMME IDÉAL POUR LES PROJETS DE DÉCORATION D'INTÉRIEUR

JEU DE REFLÈT EXCEPTIONNEL DE LA VERSION CHROME MIROIR  
ASPECT BROSSÉ, MAT POUR LE MODÈLE SATINÉ

VERSION ÉLECTRIQUE : THERMOSTAT SMART PLUS LED AVEC RÉGULATION DE LA TEMPÉRATURE, BOOST 2H, TIMER 12/24H (BOOST PROGRAMMABLE UNE OU DEUX FOIS PAR JOUR) 

 APPAREIL RÉVERSIBLE

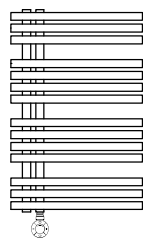
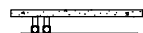

AGATA 111

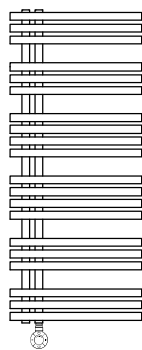

AGATA 143

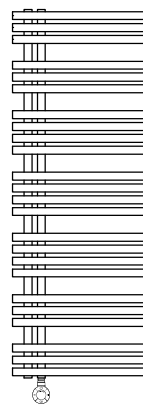

  ΔT 50 °C

77 x 50 CM  
MIROIR OU SATINÉ 300 W 224 W

  ΔT 50 °C

119 x 50 CM  
MIROIR OU SATINÉ 300 W 328 W

  ΔT 50 °C

140 x 50 CM  
MIROIR OU SATINÉ 500 W 389 W

  ΔT 50 °C

170 X 50 CM  
MIROIR OU SATINÉ 500 W 460 W

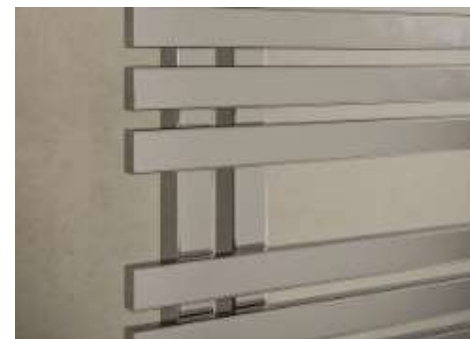

◆ FINITION CHROME MIROIR



▲ FINITION SATINÉ



# BARI.

## SÈCHE-SERVIETTES HYDRAULIQUE / ÉLECTRIQUE / MIXTE



DESIGN HORS DU COMMUN ET AVANTAGES FONCTIONNELS

APPAREIL RÉVERSIBLE, ENGAGEMENT DES LINGES DE LA DROITE OU DE LA GAUCHE

VERSION ÉLECTRIQUE : THERMOSTAT SMART PLUS LED AVEC RÉGULATION DE LA TEMPÉRATURE, BOOST 2H, TIMER 12/24H (BOOST PROGRAMMABLE UNE OU DEUX FOIS PAR JOUR)

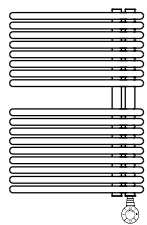

BARI 70

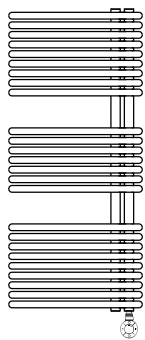

BARI 113

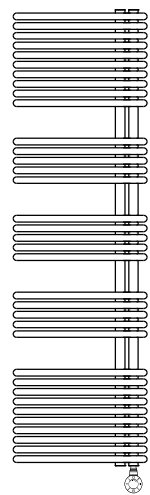

BARI 170

🔌 ⚡ ΔT 50 °C

<b>70 x 50 CM</b>			
BLANC	300 W	366 W	
ANTHRACITE	400 W	366 W	

🔌 ⚡ ΔT 50 °C

<b>70 x 60 CM</b>			
BLANC	300 W	440 W	
ANTHRACITE	400 W	440 W	

🔌 ⚡ ΔT 50 °C

<b>113 x 50 CM</b>			
BLANC	700 W	581 W	
ANTHRACITE	700 W	581 W	

🔌 ⚡ ΔT 50 °C

<b>113 x 60 CM</b>			
BLANC	700 W	640 W	
ANTHRACITE	700 W	640 W	

🔌 ⚡ ΔT 50 °C

<b>170 x 50 CM</b>			
BLANC	900 W	818 W	
ANTHRACITE	900 W	818 W	

🔌 ⚡ ΔT 50 °C

<b>170 x 60 CM</b>			
BLANC	900 W	899 W	
ANTHRACITE	900 W	899 W	



POUR PLUS DE PROGRAMMATION :  
THERMOSTAT DIGITAL DL  
ANTHRACITE OU BLANC



40 RAL À CHOIX  
NUANCIER P. 44



APPAREIL  
RÉVERSIBLE

**BARI.** HYDRAULIQUE



# ZIGZAG. NOUVEAUTÉ 2023









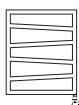

SÈCHE-SERVIENTTES HYDRAULIQUE / ÉLECTRIQUE / MIXTE  

## ZIGZAG. HYDRAULIQUE

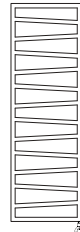
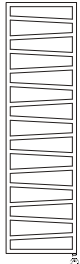
ALLIE UNE GRANDE ORIGINALITÉ EN RESTANT FONCTIONNEL

VERSION ÉLECTRIQUE : THERMOSTAT SMART PLUS LED NOIR AVEC RÉGULATION DE LA TEMPÉRATURE, BOOST 2H, TIMER 12/24H (BOOST PROGRAMMABLE UNE OU DEUX FOIS PAR JOUR) 



	<b>ZIGZAG 60</b>		<b>ZIGZAG 83,5</b>		<b>ZIGZAG 107</b>		<b>ZIGZAG 131</b>		<b>ZIGZAG 154,5</b>		<b>ZIGZAG 178</b>
<p> - 75/65/120°C</p> <p><b>60 x 50 CM</b> NOIR MAT    300 W    248 W</p>		<p> - 75/65/120°C</p> <p><b>83,5 x 50 CM</b> NOIR MAT    300 W    320 W</p>		<p> - 75/65/120°C</p> <p><b>107 x 50 CM</b> NOIR MAT    400 W    406 W</p>		<p> - 75/65/120°C</p> <p><b>131 x 50 CM</b> NOIR MAT    600 W    490 W</p>		<p> - 75/65/120°C</p> <p><b>154,5 x 50 CM</b> NOIR MAT    600 W    581 W</p>		<p> - 75/65/120°C</p> <p><b>178 x 50 CM</b> NOIR MAT    600 W    629 W</p>	



PALETTE DE 274 COULEURS  
À CHOIX P. 146 -154



VERSION ÉLECTRIQUE LIVRÉE  
AVEC THERMOSTAT SMART PLUS  
BLANC, NOIR OU CHROME



IP44

## ZIGZAG. MIXTE

# SHELF 35. NOUVEAUTÉ 2023

SÈCHE-SERVIETTES HYDRAULIQUE / ÉLECTRIQUE / MIXTE  

DESIGN NOVATEUR GRÂCE À SES TUBES PLATS HORIZONTAUX DE 35 MM DE PROFONDEUR

VERSION ÉLECTRIQUE : THERMOSTAT SMART PLUS LED NOIR AVEC RÉGULATION DE LA TEMPÉRATURE, BOOST 2H, TIMER 12/24H (BOOST PROGRAMMABLE UNE OU DEUX FOIS PAR JOUR) 

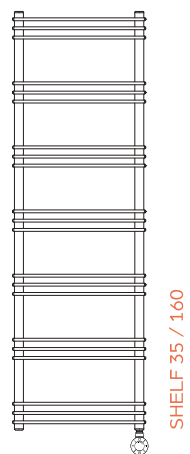
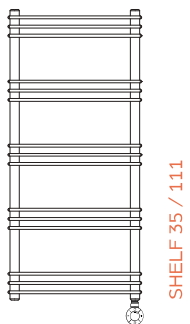
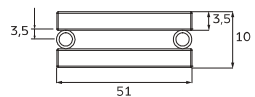

  ΔT 50 °C

**62 x 51 CM**  
BLANC 400 W 318 W  
NOIR MAT 400 W 318 W

  ΔT 50 °C

**111 x 51 CM**  
BLANC 700 W 530 W  
NOIR MAT 700 W 530 W

  ΔT 50 °C

**160 x 51 CM**  
BLANC 900 W 745 W  
NOIR MAT 900 W 745 W



34 COULEURS À CHOIX  
NUANCIER P. 160-161

**SHELF 35. HYDRAULIQUE**

# SHELF 70.

NOUVEAUTÉ 2023

## SÈCHE-SERVIETTES HYDRAULIQUE / ÉLECTRIQUE / MIXTE



DESIGN NOVATEUR GRÂCE À SES TUBES PLATS HORIZONTAUX DE 70 MM DE PROFONDEUR

LA VERSION SHELF 70 EST DISPONIBLE EN 41 OU 51 CM DE LARGE

VERSION ÉLECTRIQUE : THERMOSTAT SMART PLUS LED NOIR AVEC RÉGULATION DE LA TEMPÉRATURE, BOOST 2H, TIMER 12/24H (BOOST PROGRAMMABLE UNE OU DEUX FOIS PAR JOUR)

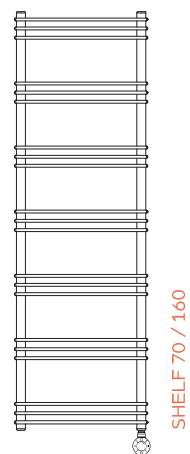
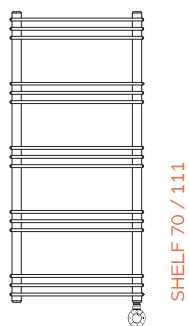
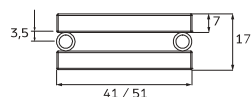

⚡ ΔT 50 °C

**62 x 41 CM**  
BLANC 400 W 397 W  
NOIR MAT 400 W 397 W

⚡ ΔT 50 °C

**111 x 41 CM**  
BLANC 900 W 661 W  
NOIR MAT 900 W 661 W

⚡ ΔT 50 °C

**160 x 41 CM**  
BLANC 1000 W 926 W  
NOIR MAT 1000 W 926 W

⚡ ΔT 50 °C

**62 x 51 CM**  
BLANC 700 W 493 W  
NOIR MAT 700 W 493 W

⚡ ΔT 50 °C

**111 x 51 CM**  
BLANC 1000 W 822 W  
NOIR MAT 1000 W 822 W

⚡ ΔT 50 °C

**160 x 51 CM**  
BLANC 1400 W 1151 W  
NOIR MAT 1400 W 1151 W



34 COULEURS À CHOIX  
NUANCIER P. 160-161

**SHELF 70.** HYDRAULIQUE

# SPINNAKER.

SÈCHE-SERVIENTTES HYDRAULIQUE / ÉLECTRIQUE / MIXTE



RADIATEUR SÈCHE-SERVIENTTES INSPIRÉ DES VOILES D'UN BATEAU

PROFILS PLATS HORIZONTAUX DE 50 x 10 MM ET COLLECTEURS 30 x 30 MM, ENTRAXE 50 MM

VERSION ÉLECTRIQUE : THERMOSTAT SMART PLUS LED AVEC REGULATION DE LA TEMPÉRATURE, BOOST 2H, TIMER 12/24H (BOOST PROGRAMMABLE UNE OU DEUX FOIS PAR JOUR)

APPAREIL RÉVERSIBLE

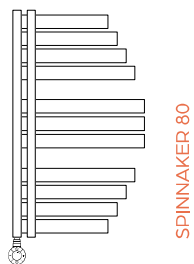

SPINNAKER 80

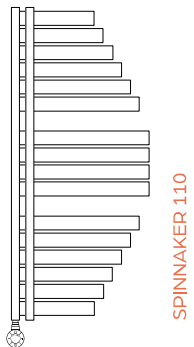

SPINNAKER 110

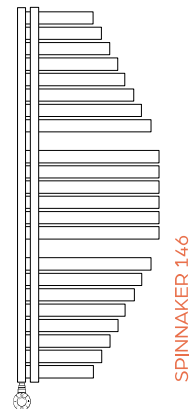

SPINNAKER 146

ΔT 50 °C

80 x 46,3 CM  
BLANC 300 W 309 W

ΔT 50 °C

110 x 48,3 CM  
BLANC 300 W 399 W  
ANTHRACITE 300 W 399 W

ΔT 50 °C

146 x 54,7 CM  
BLANC 600 W 536 W  
ANTHRACITE 600 W 536 W

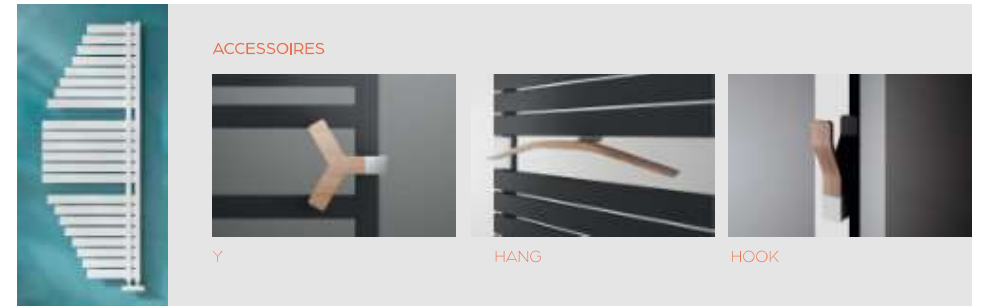

40 RAL À CHOIX  
NUANCIER P. 44

SPINNAKER. HYDRAULIQUE



# MAXINOX.

SÈCHE-SERVIETTES HYDRAULIQUE / ÉLECTRIQUE / MIXTE



TUBES INOX DE 25 MM

DESIGN ÉPURÉ POUR CE MODÈLE 100% INOX

TUBES INOX DE 25 MM

VERSION ÉLECTRIQUE ÉQUIPÉ D'UN THERMOSTAT ANALOGIQUE THESIS (RÉGULATION, BOOST 2H)

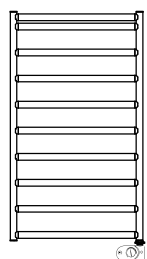

MAXINOX 86

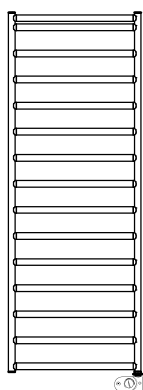

MAXINOX 135

$\Delta T 50^{\circ}C$

**86 x 50 CM**  
INOX 300 W 190 W

$\Delta T 50^{\circ}C$

**135 x 50 CM**  
INOX 500 W 290 W

$\Delta T 50^{\circ}C$

**86 x 60 CM**  
INOX 300 W 220 W

$\Delta T 50^{\circ}C$

**135 x 60 CM**  
INOX 500 W 330 W



# STILÉ.

SÈCHE-SERVIETTES HYDRAULIQUE / ÉLECTRIQUE / MIXTE



MODÈLE EN ACIER INOX SATINÉ BÉNÉFICIAANT D'UNE TRÈS BELLE FINITION

VERSION ÉLECTRIQUE : THERMOSTAT SMART PLUS LED CHROME AVEC REGULATION DE LA TEMPÉRATURE, BOOST 2H, TIMER 12/24H (BOOST PROGRAMMABLE UNE OU DEUX FOIS PAR JOUR)

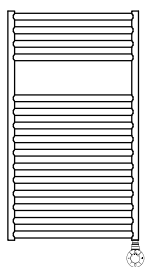

STILÉ 84

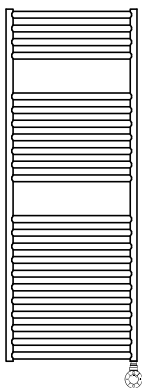

STILÉ 129

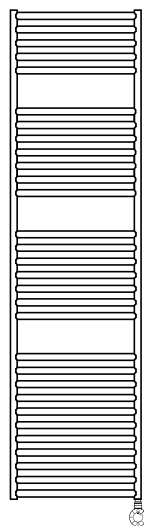

STILÉ 179

— —  $\Delta T 50^{\circ}C$

**84 x 48 CM**  
INOX 300 W 237 W

**84 x 58 CM**  
INOX 300 W 279 W

— —  $\Delta T 50^{\circ}C$

**129 x 48 CM**  
INOX 500 W 361 W

**129 x 58 CM**  
INOX 500 W 424 W

— —  $\Delta T 50^{\circ}C$

**179 x 48 CM**  
INOX 500 W 507 W

**179 x 58 CM**  
INOX 700 W 597 W



STILÉ. HYDRAULIQUE

## VELA.

SÈCHE-SERVIETTES HYDRAULIQUE / ÉLECTRIQUE / MIXTE



PARTICULARITÉ : CE MODÈLE EST DISPONIBLE AVEC UNE LARGEUR DE 76 CM

SÈCHE-SERVIETTES EN ACIER CHROMÉ OU COULEURS AVEC ÉLÉMENTS PLATS HORIZONTAUX DE 50 X 20 MM. COLLECTEURS LATÉRAUX À SECTIONS SEMI-OVALE 40 X 30 MM

THERMOSTAT SMART PLUS LED CHROME AVEC REGULATION DE LA TEMPÉRATURE, BOOST 2H, TIMER 12/24H (BOOST PROGRAMMABLE UNE OU DEUX FOIS PAR JOUR)

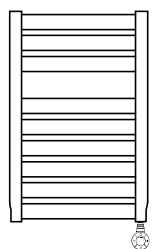

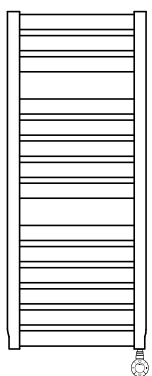

VELA 70



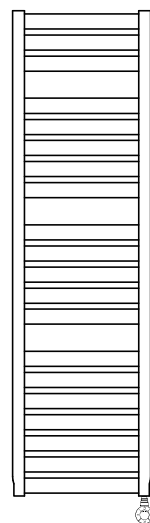

VELA 112





VELA 161



 $\Delta T 50^\circ C$   
**70 x 46 CM**  
 BLANC  
 COULEUR\*

300 W 314 W



 $\Delta T 50^\circ C$   
**112 x 46 CM**  
 BLANC  
 COULEUR\*

400 W 470 W





 $\Delta T 50^\circ C$   
**161 x 46 CM**  
 BLANC  
 COULEUR\*

700 W 676 W





 $\Delta T 50^\circ C$   
**70 x 56 CM**  
 COULEUR\*



400 W 359 W



 $\Delta T 50^\circ C$   
**112 x 56 CM**  
 CHROME  
 COULEUR\*



400 W 552 W  
400 W 552 W



 $\Delta T 50^\circ C$   
**161 x 56 CM**  
 CHROME  
 COULEUR\*



700 W 805 W  
700 W 805 W



 $\Delta T 50^\circ C$   
**70 x 76 CM**  
 COULEUR\*

500 W 451 W



 $\Delta T 50^\circ C$   
**112 x 76 CM**  
 COULEUR\*

600 W 717 W



 $\Delta T 50^\circ C$   
**161 x 76 CM**  
 COULEUR\*

1000 W 1062 W



\* 50 RAL À CHOIX NUANCIER P. 156-158  
CLASSIC & SPECIAL

VELA. HYDRAULIQUE

# TOLÉ.

SÈCHE-SERVIETTES HYDRAULIQUE / ÉLECTRIQUE / MIXTE



RADIATEUR EN ALUMINIUM CHROMÉ AVEC REFLETS CHROME NOIR

PROFILS HORIZONTAUX CARRÉS DE 22 x 22 MM ET COLLECTEURS LATÉRAUX DE 25 x 25 MM

EXCELLENTE RÉSISTANCE À LA CORROSION ET AUX RAYURES

JEU DE MONTAGE DISCRET MONTÉ SUR LES COLLECTEURS

THERMOSTAT SMART PLUS LED CHROME AVEC REGULATION DE LA TEMPÉRATURE, BOOST 2H, TIMER 12/24H (BOOST PROGRAMMABLE UNE OU DEUX FOIS PAR JOUR)

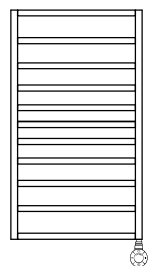

TOLÉ 84

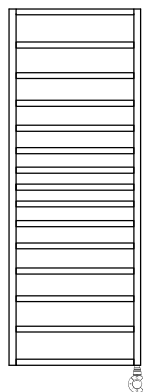

TOLÉ 131

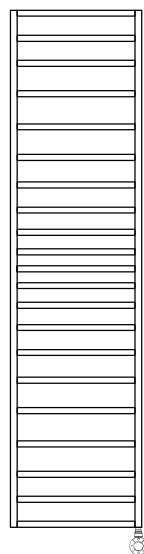

TOLÉ 190

— —  $\Delta T 50^{\circ}C$

**84 x 48 CM**  
CHROME 200 W 231 W

**84 x 58 CM**  
CHROME 200 W 273 W

— —  $\Delta T 50^{\circ}C$

**131 x 48 CM**  
CHROME 300 W 344 W

**131 x 58 CM**  
CHROME 500 W 396 W

— —  $\Delta T 50^{\circ}C$

**190 x 48 CM**  
CHROME 500 W 501 W

**190 x 58 CM**  
CHROME 700 W 578 W



TOLÉ. HYDRAULIQUE



# STENDY.

## SÈCHE-SERVIETTES HYDRAULIQUE / ÉLECTRIQUE



SÈCHE-SERVIETTES ET ÉTENDOIR SÈCHE-LINGE

SECTIONS SUPÉRIEURES ÉQUIPÉ D'UN VÉRIN (SYSTÈME BREVETÉ BASCULANT À 90°, SECTIONS DE 37,7 CM)

JEU DE SUPPORTS DISCRET SUR LES COLLECTEURS – GARANTIE DE 5 ANS

THERMOSTAT DIGITAL AVEC ÉCRAN LCD. 9 PROGRAMMES INTÉGRÉS, 4 PROGRAMMES PERSONNALISABLES, BOOST, SÉCURITÉ ENFANT

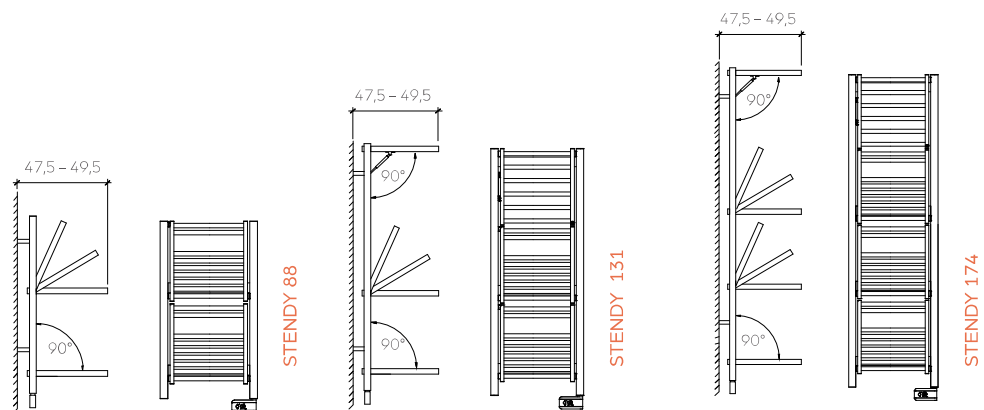

🔌 ⚡ ΔT 50 °C

**88 x 51 CM – FERMÉ**  
BLANC 300 W 390 W

**88 x 51 CM – OUVERT**  
BLANC 300 W 407 W

🔌 ⚡ ΔT 50 °C

**131 x 51 CM – FERMÉ**  
BLANC 500 W 572 W  
CHROME 300 W 409 W

**131 x 51 CM – OUVERT**  
BLANC 500 W 712 W  
CHROME 300 W 520 W

🔌 ⚡ ΔT 50 °C

**174 x 51 CM – FERMÉ**  
BLANC 750 W 725 W  
CHROME 500 W 524 W

**174 x 51 CM – OUVERT**  
BLANC 750 W 963 W  
CHROME 500 W 703 W

VERSION HYDRAULIQUE DISPONIBLE  
ÉGALEMENT EN 61 CM DE LARGE



VERSION ÉLECTRIQUE  
LIVRÉE AVEC THERMOSTAT  
DIGITAL AVEC ÉCRAN LCD



NOMBREUX RAL DISPONIBLES : BRILLANTS,  
MATS OU STRUCTURÉS. NUANCIER P. 155

# STENDY. ÉLECTRIQUE

# STENDY SHORT.

NOUVEAUTÉ 2023

## SÈCHE-SERVIETTES HYDRAULIQUE / ÉLECTRIQUE



VERSION ÉLECTRIQUE LIVRÉE  
AVEC THERMOSTAT BLUETOOTH  
AVEC AFFICHAGE OLED



SÈCHE-SERVIETTES ET ÉTENDOIR SÈCHE-LINGE SUR 2, 3 OU 4 ÉTAGÈRES

SYSTÈME BREVETÉ BASCULANT À 90°, SECTIONS DE 20,7 CM

JEU DE SUPPORTS DISCRET SUR LES COLLECTEURS – GARANTIE DE 5 ANS

THERMOSTAT BLUETOOTH AVEC AFFICHAGE OLED PERMETTANT UNE GESTION À DISTANCE.  
APPLICATION POUR ANDROID ET IOS

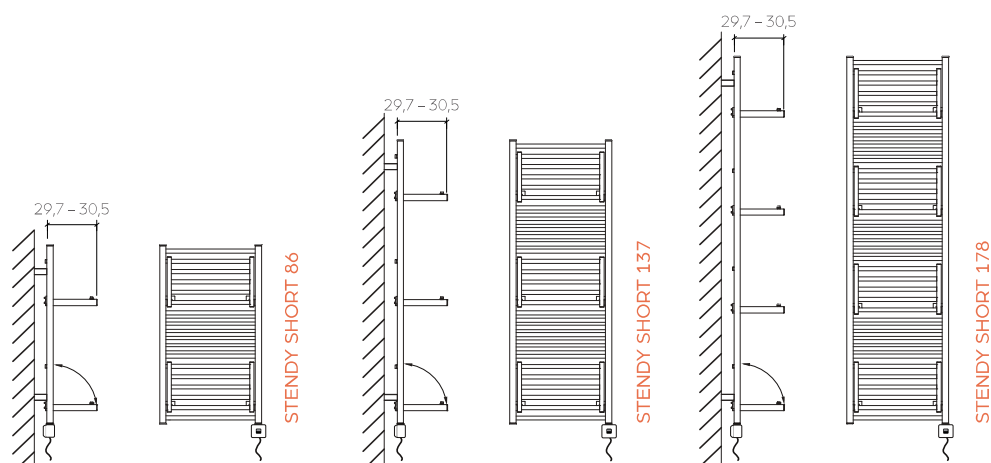

🔌 ⚡ ΔT 50 °C

**86 x 48 CM – FERMÉ**  
BLANC 300 W 374 W  
(ET COULEURS)

**86 x 48 CM – OUVERT**  
BLANC 300 W 430 W  
(ET COULEURS)

🔌 ⚡ ΔT 50 °C

**137 x 48 CM – FERMÉ**  
BLANC 500 W 605 W  
CHROME 300 W 435 W

**137 x 48 CM – OUVERT**  
BLANC 500 W 695 W  
CHROME 300 W 500 W

🔌 ⚡ ΔT 50 °C

**178 x 48 CM – FERMÉ**  
BLANC 750 W 782 W  
CHROME 500 W 563 W

**174 x 48 CM – OUVERT**  
BLANC 750 W 899 W  
CHROME 500 W 647 W

📏 VERSION HYDRAULIQUE DISPONIBLE  
ÉGALEMENT EN 58 CM DE LARGE



## STENDY SHORT. ÉLECTRIQUE



NOMBREUX RAL DISPONIBLES : BRILLANTS,  
MATS OU STRUCTURÉS. NUANCIER P. 155